

Low -Cost Holding Cabinet Control System

(2 x 2 with Double Heaters, Front Only SPS-101 Buttons)

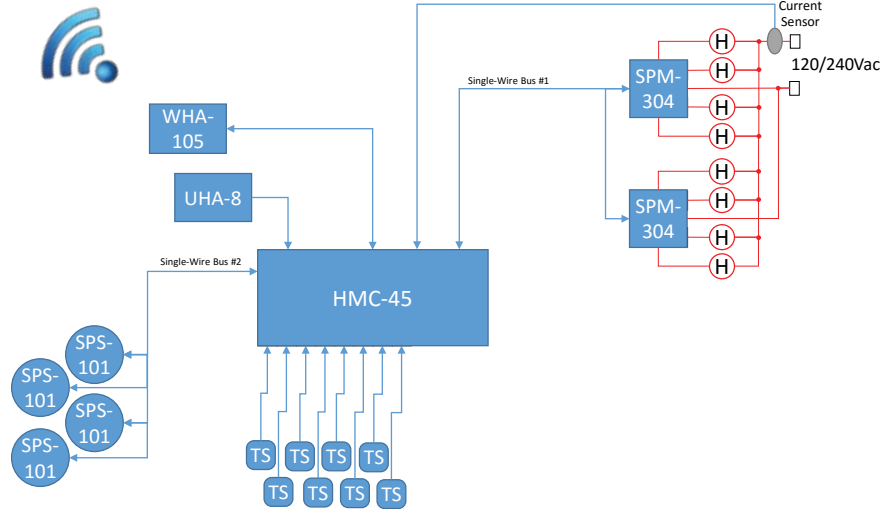

HMC-45



SPS-101



SPM-304



WHA-105



UHA-08

Our revolutionary Low Cost Holding Cabinet Control System allows for complete, reliable, and affordable control over any commercial holding oven via a combination of innovative new Renau Single-Wire Network products, intuitive and simple wireless communication, and advanced diagnostic features. This sample 2x2 Configuration features:

- Simple, reliable wireless communication from the WHA-105 Wi-Fi Module to mobile devices and our cloud-based Smart Kitchen Manager (SKM).
- Up to 12 independent low-cost SPS-101 Smart Panel Switches
- Full control of up to 8 heating elements
- USB-based configuration and firmware updates
- Equipment analytics and current sensing

